

MWP SERIES

Micro Weighing Scale



CAS

CONTENTS

PRECAUTIONS	4
1. Introduction	6
2. Installation	7
2.1 Unpacking	7
2.2 Illustration of the installation for plastic shield	7
2.3 Selecting the location	8
2.4 Leveling the scale	8
2.5 Connecting power	8
2.6 Initial calibration	8
3. Displayed indicators and keyboard	9
3.1 Display Symbols	9
3.2 Keypad Functions	9
4. Operations	10
4.1 Weighing mode	11
4.2 Counting mode	11
4.3 Percentage(%) mode	12
5. Parameter Set-Up	13
5.1 Calibration	14
5.2 To choose the initial unit while turning on	15
5.3 To choose the “UNIT” you need	16
5.4 To choose the time of AUTO OFF	17
5.5 To choose output transmission method	18
5.6 Baud rating setting for RS232 interface	19
5.7 To choose the range of stability	20
5.8 To choose the Zero display range	21
5.9 To choose the Zero Recovery display range	22
5.10 To choose the auto-average in sampling on counting mode	23
5.11 To choose the Backlight mode	24
6. Auto calibration	25
7. Recovery of the default values from memory	25
8. Error messages	25
9. Specification of RS-232 interface	26
10. Conversion units table for weights	28
11. Table list for full capacity	28
12. Technical Data	29

PRECAUTIONS

Warning

Precautions when installing the scale. To ensure that you get the most from your scale, please follow these instruction.

Do not disassemble the scale.

When any damage or defect occurs, contact your CAS authorized dealer immediately for proper repair.



Do not overload beyond the maximum weight limit.

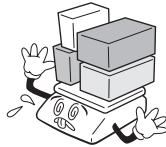

Scale must be grounded to minimize electricity static.

This will minimize defect or electric shock.



Do not pull the plug by its cord when unplugging.

Damaged cord could cause electric shock or fire.



To prevent from fire occurring, Do not place or use the scale near flammable or corrosive gas.

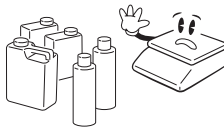

To reduce electric shock or incorrect reading, Do not spill water on the scale or place it in humid condition.

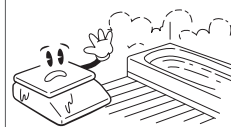

Avoid placing the scale near heater or in direct sunlight.

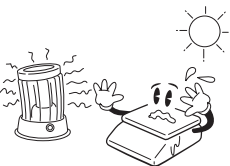

Insert plug firmly to wall outlet to prevent electric shock.

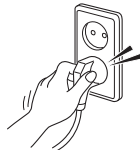

Use proper Adapter.

Incorrect adapter could damage the scale.

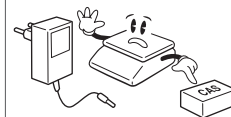

PRECAUTIONS

Attention

Make sure to plug your scal into the proper power outlet. For maximum performance, plug into a power outlet 30 minutes before the usage for warm up.

For consistent and accurate reading, maintain periodical check by your CAS authorized dealer.

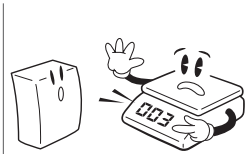

Avoid sudden shock to the scale.



Grab on the bottom of the scale when moving.



Keep the scale away from other electromagnetic engering devices.

This may interfere with accurate reading.

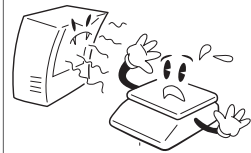

Place the scale on firm and temperature consistent environment.



By adjusting 4 corners of the scale, set the scale even using the built in scale leveling indicator.



Take the battery out when scale is not in use for long time. Leakage from the batteries is hazardous.

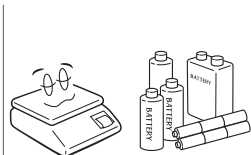

1. INTRODUCTION

The scale is very simple to use and are applicable for general weighing.

The user can also use the parts counting and percent weighing functions for special applications. Special functions are available for weighing in up to 8 different units of weight.

For safe and dependable operation of this scale, please comply with the following

Safety Precautions :

- Verify that the input voltage printed on the AC Adapter and the plug type matches the local AC power supply.
- Make sure that the power cord does not pose a potential obstacle or tripping hazard.
- Disconnect the scale from the power supply when cleaning the scale.
- Do not operate the scale in hazardous or unstable environments.
- Do not immerse the scale in water or other liquids.
- Do not drop loads on the platform.
- Use only approved accessories and peripherals, as available.
- Operate the scale only under ambient conditions specified in these instructions.
- Service should be performed by authorized personnel only.
- It must not be bump against other items or overloaded with excessively heavy weights (The load must not exceed the maximum capacity of the balance).

2. INSTALLATION

2.1 Unpacking

Unpack and verify that the following components have been included:

- Scale
- Steel Pan
- Instruction Manual
- AC Adapter
- CD-ROM(for the scale with USB interface only)
- USB Cable(for the scale with USB interface only)
- Five pieces of wind shield

Save the packaging material. This packaging ensures the best possible protection for the storage or transport of the product.

2.2 Illustration of the Installation for Plastic Shield

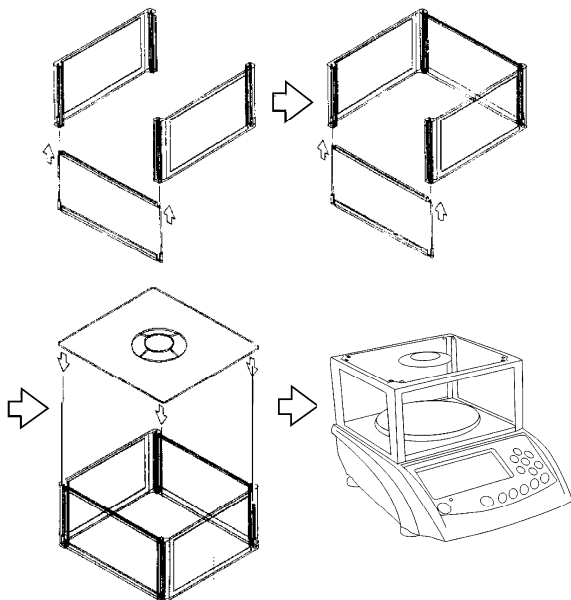

2.3 Selecting the Location

Operate the scale on a firm, level surface. Avoid locations with rapid temperature changes, excessive dust, moisture, air currents, vibrations, electromagnetic fields, heat or direct sunlight.

2.4 Leveling the scale

Adjust the leveling feet until the bubble is centered in the circle of the level indicator (located on the front panel).

NOTE : Ensure that the scale is level each time its location is changed.

2.5 Connecting Power

2.5.1 AC Power

Verify that the intended AC power source matches the AC adapter rating.

Connect the supplied AC adapter to the power input receptacle at the back of the scale. Plug the AC adapter into a properly grounded power outlet.

2.5.2 Battery Power

The battery will begin charging with the AC adapter connected accordingly.

An LED indicator below and to the left of the scale shows the status of battery charging:

- Green-battery is fully charged
- Yellow-battery is partially charged and charging
- Red-battery is nearly discharged

When AC power is not available, the scale will operate on the internal rechargeable battery. The scale will automatically switch to battery operation if there is a power failure or the power cord is removed.

Low battery charge is indicated by the  annunciator.

Before using the scale for the first time, the internal rechargeable battery should be fully charged for up to 12 hours. A fully charged battery can operate the scale for approximately 80 hours independent of AC power. The battery is protected against overcharging and the scale can remain connected to the AC power line.

NOTE :

- The battery must be recharged every 3 months if the scale is not used for a long time.
- Dispose of the lead acid battery according to local laws and regulations.

2.6 Initial Calibration

When the scale is operated for the first time, a Span Calibration is recommended to ensure accurate weighing results. Before performing the calibration, be sure to have the appropriate calibration weights.

Refer to Section 6 for AUTO CALIBRATION.





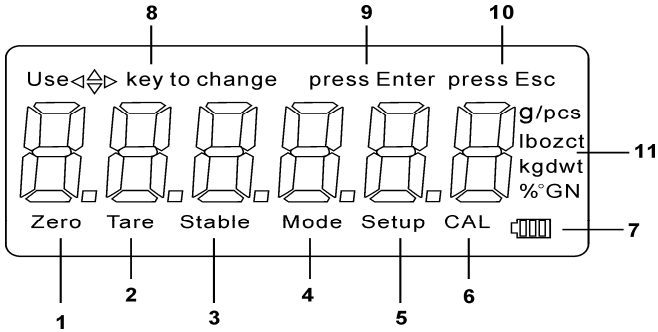







3. DISPLAYED INDICATORS AND KEYBOARD

3.1 Display Symbols



1	Zero – Is displayed when the “Zero” key is pressed.	
2	Tare – Is displayed when the “Tare” key is pressed.	
3	Stable – Stable indication, scale is in stable condition.	
4	Mode - Is displayed when the “Mode” key is pressed.	
5	Setup - Is displayed when the “Setup” key is pressed.	
6	CAL - Is displayed when the scale is in Calibration Mode.	
7	- Power indication.	
8	Use key to change – Used to prompt the user while navigating through the menu system.	
9	Press Enter – Used as a prompt to the user to press the Enter key. The menu item displayed is selected.	
10	Press Esc – Used as a prompt to the user to press the Esc key to return to last menu or exit Setup Mode.	
11	Symbols for weighing units and modes, include :	
	Ct	- Carats
	lb	- Pounds
	oz	- Ounces
	GN	- Grain
	ozt	- Ounces troy
	dwt	- Pennyweight
	t1.T	- Tael
	pcs	- Parts counting
	%	- Percent weighing
°C	- Temperature	

3.2 Keypad Functions

	ON/OFF switch
	Function key to choose weighing, counting, percentage
	"Unit" selection, 8 units are available
	Sample key to set the unit weight of sample
	Tare key to deduct the container weight
	Zero key, press this key, the weight will become "0"
	Confirmation key and print key
	Selects various menus
	Return to last menu or exit Setup Mode
	Travels to the left through menus
	Travels to the right through menus
	Travels to the up through menus
	Travels to the down through menus

4. OPERATIONS

Press the  key for power on, the scale will be on the weighing mode using the initial unit of weight selected.

4.1 Weighing Mode

4.1.1 Units selection

Press the  key to choose the weighing units and the display will be changed to the new value with the units shown. There are up to 8 units of weight that can be enabled.

4.1.2 Zero Function

If the zero shifts during operation, press the  key to set it to zero. The Zero function is only active over $\pm 2\%$ of full capacity.

4.1.3 Tare function

Tare weight is the weight of a container and can be subtracted by placing an empty container on the scale. When the display is stable, press the  key. The display will become zero and the display will have a tare indication.





Cancel the tare function by pressing the  key with no weight on the scale. Tare range is the full capacity of the scale.

4.1.4 Over load alarm

When the weight on the scale is more than Max. capacity, the display shows “—OL—” at the same time the buzzer sounds. Please take off the weight at once. Otherwise the scale will be easily damaged.

4.2 Counting Mode

The scale will count parts by weighing a preset number of samples and setting the display to show the number. Then, as more samples are added, the display will increase. If necessary, place a container on the scale and press  key before beginning.

After selecting parts counting with the  key,  press the or ,  key to select the sample size (10, 20, 50, 100 pcs)

Put the sample number (same as selected) on the scale and press  key. When the symbol “C” disappears the sampling procedure is finished and you can start to use counting function.

If the unit weight is too small (less than 0.2 of a scale division), the display will show: “—or—pcs.” It would be best to use larger parts or to use ten times as many parts as required and reduce the displayed values to 1/10th.

4.3 Percentage(%) Mode

After selection % Weighing with the  key press the  or   key to choose either 100.0%, 100.00%.

Put the item to be considered 100% onto the pan and press the  key to sample, at the same time the symbol "Mode" flash, after several seconds the symbol "Mode" disappears and the buzzer sounds the sampling procedure is finished and you can start to use the percentage function.

When the value of the sample is smaller than 0.2d, the display will show"—or—". It means that the sample is too small, larger parts should be put on.

NOTE :



- When you finish the procedures of selecting the sample size in the counting mode or percentage(%) mode, press the  key to change back to the weighing mode.

Press the  key to return to counting or percentage mode.

The scale will memorize the previous data automatically so that you can continue to count parts or weigh in percentage.

- The memory of sampling size data will be cleared automatically when the two modes of counting and percentage switch reciprocally.

5. PARAMETER SET-UP



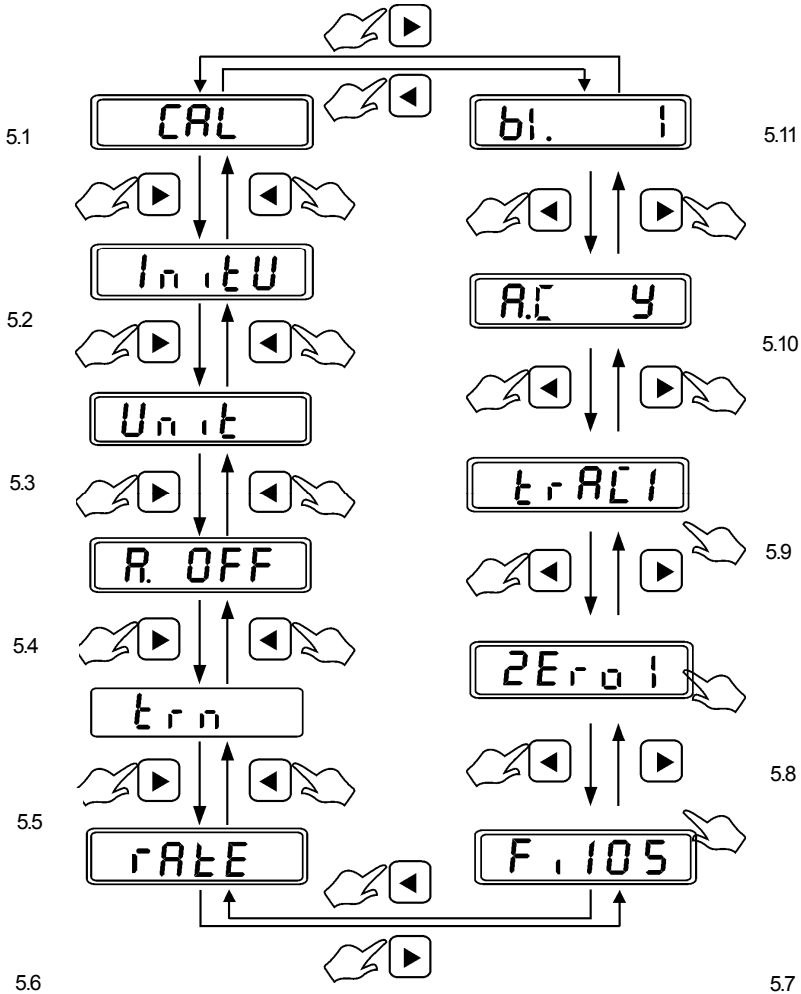

Press  key to enter SETUP PARAMETER mode during in weighing mode, and the display shows "CAL". The functions will change by pressing ,  key. The functions are :

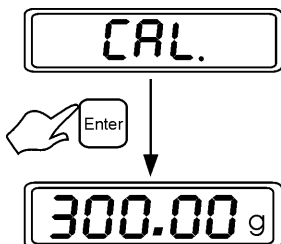

5.1 Span calibration

When the display shows “CAL”, press the  key to enter Auto calibration.



Please use ,  and ,  key to key in the mass values which you are going to calibrate, then press  key to confirm the value. When the display is flashing and showing the weight values, put the mass on scale. While scale is stable, the scale will return back to weighing mode. The calibration procedure is finished.

NOTE :

- **Mass Value** : Any over (full calibration \times 10%)weight of key in value is acceptable to calibrate.
- **Suggestion** : Generally. If the calibrated weight is over half load capacity or full load capacity, it will be good for getting the precise accuracy.
Another method for auto calibration, please see the section 6
“AUTO CALIBRATION.”
- During in calibration procedure, you can press the  key to exit calibration function.

5.2 To choose the initial unit while turning on

Please press **Units** or **▲** , **▼** key to select the unit, then press **Enter** key to confirm.

Press **Esc** key to return to last menu or exit.

(Factory setting : “g”)

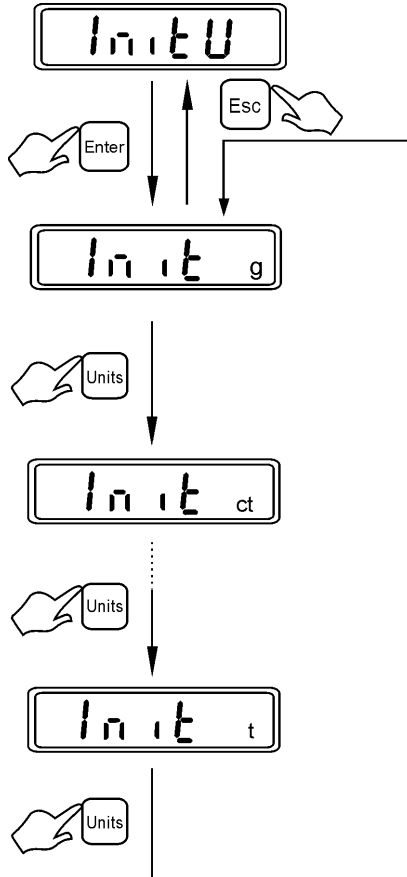



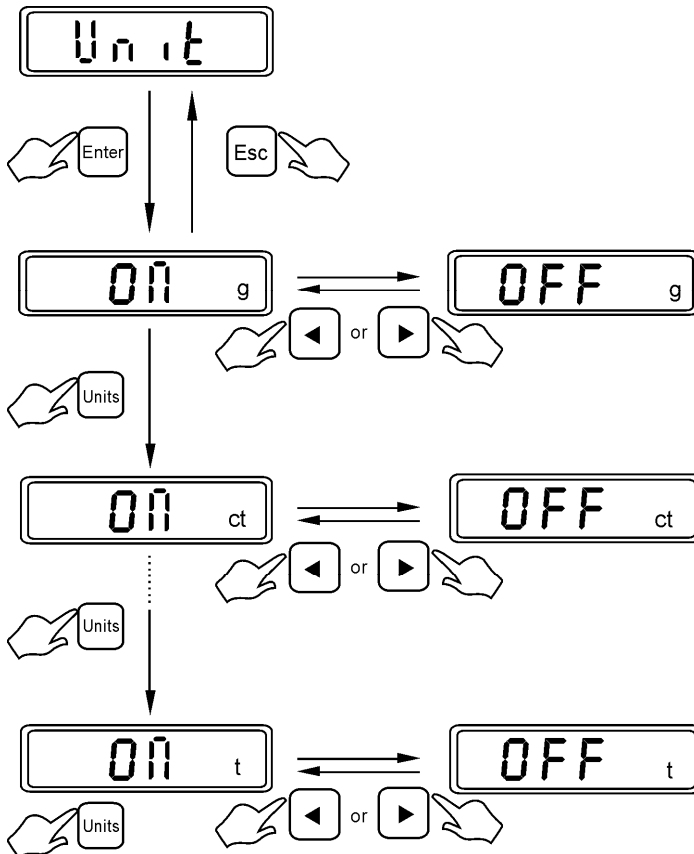

5.3 To choose the “UNIT” you need (Total 8 units, you can choose some of them you need to use)

Press **Units** or **▲**, **▼** key to move the unit, then press **◀**, **▶** key to choose “ON” or “OFF” and press **Enter** key to confirm.

Press **Esc** key to return to last menu or exit.
(Factory setting : total 8 units are on)





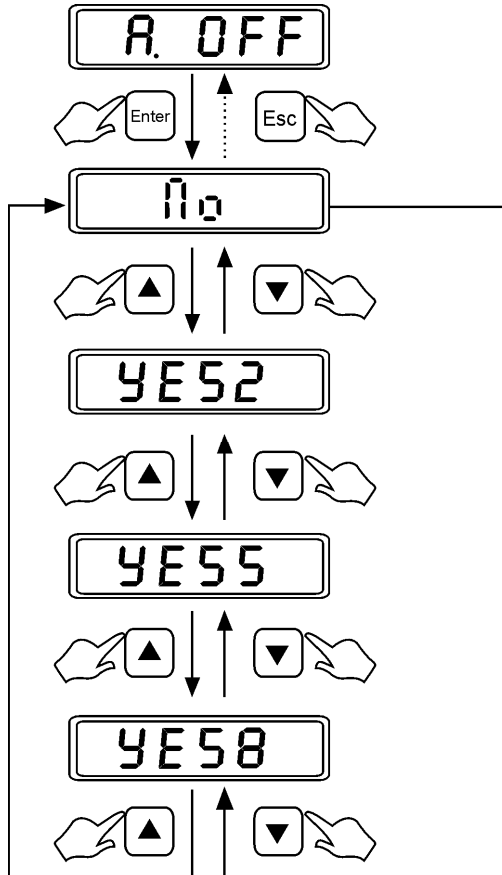

5.4 To choose the time of AUTO OFF

Press  ,  key to select the time of auto off .i.e.no,2,5 or 8 minutes, then press  key to confirm. Press  key to return to last menu or exit.
(Factory setting : “no”)





5.5 To choose output transmission method

Press ,  key to select "stable transmit", press  key to confirm.

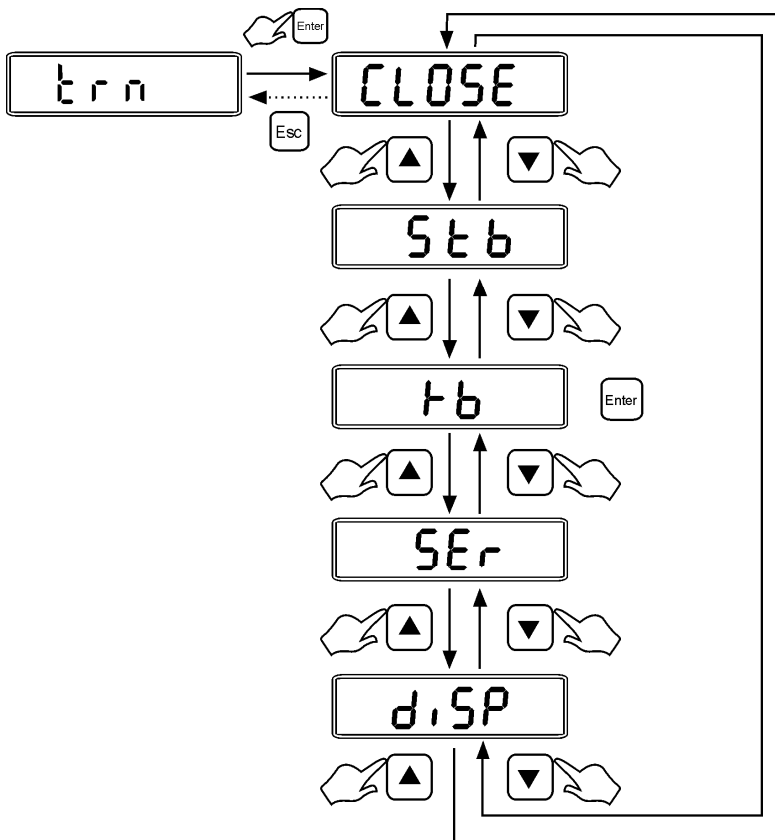
Press  key to return to last menu or exit.
(Factory setting : "close")



5.6 Baud rate setting for RS232 interface



Use ,  key to select the baud rate you need 1200,2400,4800, 9600

Press  key to confirm. Press  key to return to last menu or exit.

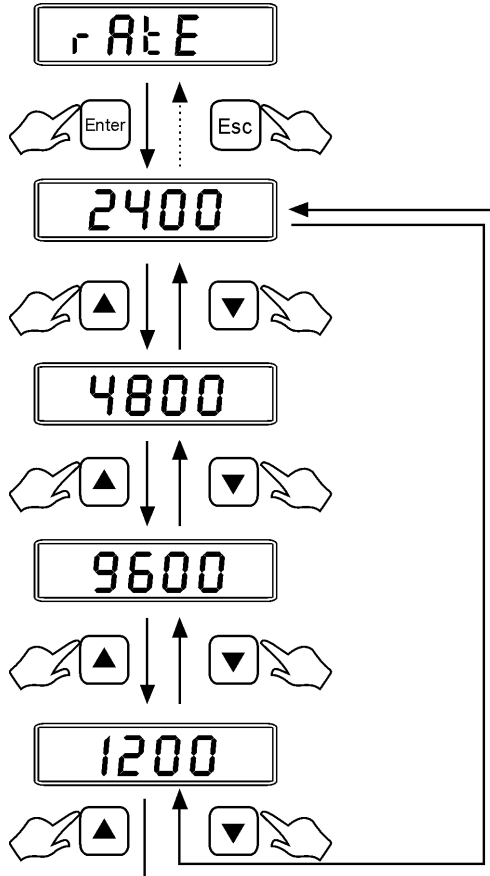
(Factory setting : 2400)



5.7 To choose the range of stability

Use ,  key to select the range of stability from 1 to 15. Then press  key to confirm.



Press  key to return to last menu or exit.

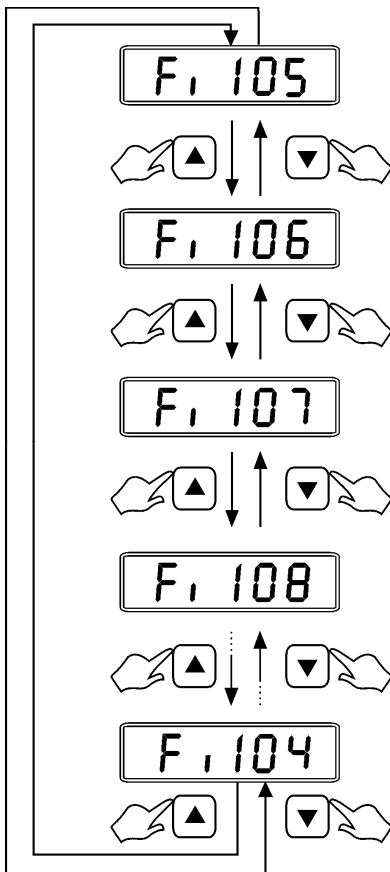

The bigger the figures you choose, the quicker the stability of display will be got.

(Factory setting: "05")





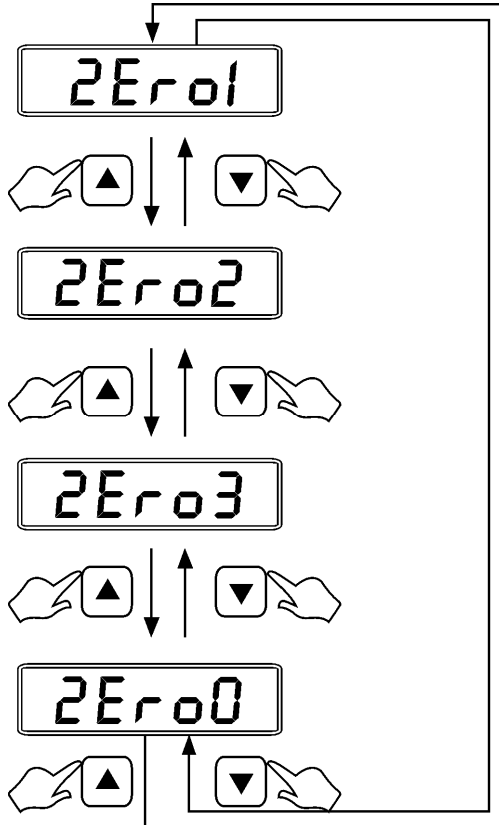

5.8 To choose the Zero display range

Press  ,  key to select the zero display range from 0 to 3

Divisions, then press  key to confirm. Press  key to return to last menu or exit.
(Factory setting : "1")





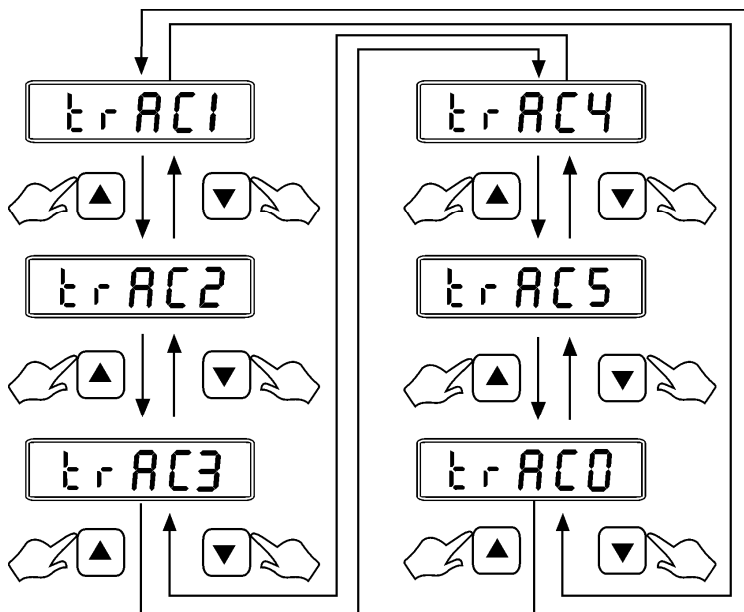

5.9 To choose the Zero Recovery display range

Press ,  key to select the display range of zero recovery from 0 to 3 divisions, press  key to confirm. Press  key to return to last menu or exit.
(Factory setting : "2")



5.10 To choose the auto-average in sampling on counting mode



Press  ,  key to select the auto-average (Yes or No). Then press  key to confirm.

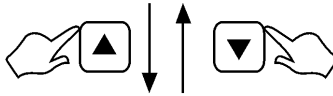
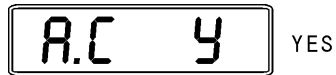

Press  key to return to last menu or exit.

(Factory setting : “YES”)



5.11 To choose Backlight Mode

Press ,  key to select the backlight mode(1,2,3 can be chosen).

The press  key to confirm. Press  key to return to last menu or exit.
(Factory setting : bl.1)

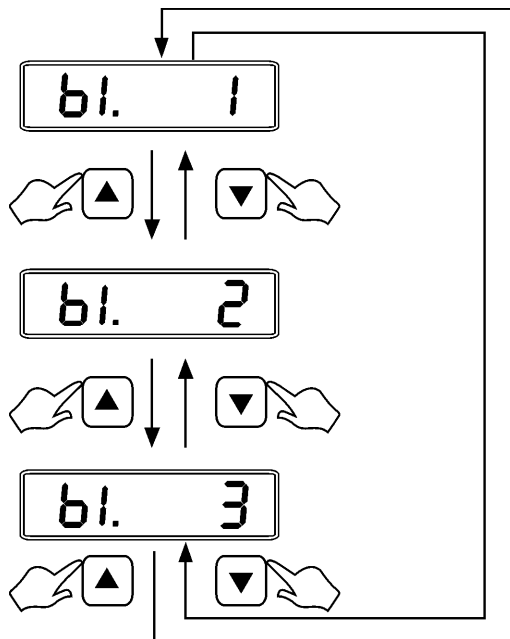

"bl.1"=Auto backlight

"bl.2"=Backlight will always be on

"bl.3"=No backlight

6. AUTO CALIBRATION

Press the  key for about 3 seconds. The display will show the “Calibration weight value.” Put the same weight on the pan. When the “CAL” symbol disappears, the calibration procedure is finished.

7. RECOVERY OF THE DEFAULT VALUES FROM MEMORY

During in weighing mode, hold down the  key for 3 seconds. The scale will come back with a default calibration values.

8. ERROR MESSAGES

During self test the scale verifies operation and the load cell.

Error messages are: “*E 1 . E 2 . E 5 . 0 L*” messages.

These messages may also be shown if the pan is not installed correctly or the environment is not suitable.

Contact your dealer for assistance.

9. SPECIFICATION OF OUTPUT INTERFACE

1) Model : EIA-RS-232 C's UART signal, or USB signal.

2) Format

- a. Baud rate : 2400 BPS, 4800 BPS
- b. Data bits : 7 BITS
- c. Parity bit : 1 EVEN
- d. Stop bit : 1 BIT
- e. Code : ASCII

RS-232 connector is a 9 pin D-subminiature socket.

Input Pin 2
 Output Pin 3
 Signal Ground Pin 5

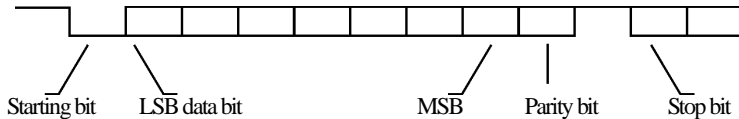

3) DATA FORMAT

HEAD1 , HEAD2 , DATA UNIT CR
 12 3 45 6 7 8 9 10 11 12 13 14 15 16 17 18 19 20

HEAD1 (2 BYTES) HEAD2 (2 BYTES)

OL-Overload, NT-NET Mode

ST-Display is Stable GS-Gross Weight

US-Display is Unstable

DATA(8BYTES)

2D (HEX)='-'(MINUS) 20(HEX)=' '(SPACE)

2E (HEX)='.'(DECIMALPOINT)

UNIT(4BYTE)

g-20 (HEX); 20 (HEX); 20 (HEX); 67 (HEX)

lb-20 (HEX); 20 (HEX); 6c (HEX); 62 (HEX)

TL.T-74 (HEX); 6C (HEX); 2E (HEX); 54 (HEX)

4) Transmit Example

EX+0.876g, when it is stable and net value as:

HEAD,	HEAD,	DATA	UNIT	CR
ST , NT ,		+ 0.876	g	0D 0A

EX-1.568lb, when it is unstable and net value as:

HEAD,	HEAD,	DATA	UNIT	CR
US , NT ,		- 1.568	lb	0D 0A

EX+15.24t.T, when it is stable and net value as:

HEAD,	HEAD,	DATA	UNIT	CR
ST, NT ,		+15.24	t.T	0D 0A

10. CONVERSION UNITS TABLE FOR WEIGHTS

1 ct (MET.CARAT)	=0.1999694 g
1 lb(AVOIRDUPOIS POUND)	=453.59237 g
1 oz(AVOIRDUPOIS OUNCE)	=28.349523125g
1 GN(GRAIN)(U.K)	=0.06479891 g
1 ozt (TROY OUNCE)	=31.1034768 g
1 dwt(PENNYWEIGHT)	=1.55517384 g
1 tl.T(TAEL)(TWN)	=37.799375 g

11. TABLE LIST FOR FULL CAPACITY

	150g X 0.005g	300g X 0.01g	600g X 0.01g	1500g X 0.05g	3000g X 0.1g
g	150.045	300.09	600.18	1500.45	3000.9
ct	750.18	1500.45	3000.9	7501.8	15004.5
lb	0.33018	0.66045	1.3009	3.3018	6.6045
oz	5.2018	10.5045	21.009	52.018	100.045
GN	2300.9	4601.8	9204.5	23009	46018
ozt	4.8018	9.6045	19.009	48.018	96.045
dwt	96.045	190.09	380.18	960.45	1900.9
tl.T	4.0018	8.0045	16.009	40.018	80.045

12. TECHNICAL DATA

Capacity x Readability	150X 0.005g	300X 0.01g	600X .02g	1500X 0.05g	3000X 0.1g	300X 0.005g	600X 0.01g	1200X 0.02g	3000x 0.05g
Maximum Displayed Resolution	1:30000	1:30000	1:30000	1:30000	1:30000	1:60000	1:60000	1:60000	1:60000
Construction	ABS plastic, stainless steel platform								
Tare range	Full capacity								
Zero range	≤±2% of full capacity								
Weighing Units	G, ct, lb, oz, GN, oz t, dwt, tl, T								
Application Modes	Weighing, Counting and percentage (%)								
Display	6 digits LCD (40X95mm) with auto backlight								
Stabilization time	≤2 seconds								
Operating Temperature	0 to 40°C / 32 to 104°F								
Humidity Range	≤90% relative humidity, non-condensing								
Power	AC Adapter 12V DC/500mA & Internal rechargeable lead acid battery								
Calibration	Automatic external								
Battery life	80 hours continuous use with 12 hours recharging time								
Interface	RS-232 or USB output(Optional)								
Pan Size	150g~600g : Ø116mm (round) 1200g ~ 3000g: 124X144mm (square)								
Scale Dimensions (WxHxD)	200X80X250mm								

MWP SERIES

Micro Weighing Scale



CAS BLDG., # 440-1, SUNGNAE-DONG,
GANGDONG-GU, SEOUL, KOREA
TEL_ 82 2 2225 3500
FAX_ 82 2 475 4668
www.globalcas.com